

# Service Manual

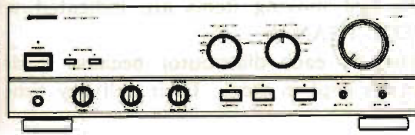

**ORDER NO.  
ARP1581**

**STEREO AMPLIFIER**

# A-443

## A-443-S

## A-333

## A-333-S

**A-443, A-443-S, AND A-333, A-333-S HAVE FIVE VERSIONS:**

Type	Applicable model				Power requirement	Destination
	A-443	A-443-S	A-333	A-333-S		
HE	○	—	○	—	AC220V, 240V (switchable)*	European continent
HB	○	—	○	—	AC220V, 240V (switchable)*	United Kingdom
HEZ	○	○	○	○	AC220V, 240V (switchable)*	West Germany
KC	○	—	—	—	AC120V only	Canada
SD	○	—	—	—	AC110V, 120V–127V, 220V, 240V (switchable)	Kingdom of Saudi Arabia and general market

\*Change the primary wiring of the power transformer.

- This manual is applicable to the A-443/HE, HB, HEZ, A-443-S/HEZ, A-333/HE, HB, HEZ and A-333-S/HEZ types.
- For the other types, refer to additional service manual.
- The A-443-S is silver versions of A-443.
- The A-333-S is silver versions of A-333.

## CONTENTS

1. EXPLODED VIEW AND PARTS LIST . . . . .	2	6. FOR A-443/HB, HEZ AND A-443-S/HEZ TYPES. . . . .	19
2. PACKING . . . . .	5	7. FOR A-333/HE, HB, HEZ AND A-333-S/HEZ TYPES . . . . .	22
3. SCHEMATIC DIAGRAM . . . . .	6	8. SPECIFICATIONS . . . . .	37
4. P.C.BOARDS CONNECTION DIAGRAM . . . . .	9	9. PANEL FACILITIES. . . . .	39
5. ELECTRICAL PARTS LIST . . . . .	16		

**PIONEER ELECTRONIC CORPORATION** 4-1, Meguro 1-Chome, Meguro-ku, Tokyo 153, Japan

**PIONEER ELECTRONICS SERVICE INC.** P.O. Box 1760, Long Beach, California 90801 U.S.A.

**PIONEER ELECTRONICS OF CANADA, INC.** 505 Cochrane Drive, Markham, Ontario L3R 8E3 Canada

**PIONEER ELECTRONIC [EUROPE] N.V.** Keetberglaan 1, 2740 Beveren, Belgium

**PIONEER ELECTRONICS AUSTRALIA PTY. LTD.** 178-184 Boundary Road, Braeside, Victoria 3195, Australia TEL: [03] 580-9911

# 1. EXPLODED VIEW AND PARTS LIST

## NOTES :

- Parts without part number cannot be supplied.
- The  $\Delta$  mark found on some component parts indicates the importance of the safety factor of the part. Therefore, when replacing, be sure to use parts of identical designation.
- For your parts Stock Control, the fast moving items are indicated with the marks  $\star\star$  and  $\star$ .  
 $\star\star$  GENERALLY MOVES FASTER THAN  $\star$ .  
 This classification shall be adjusted by each distributor because it depends on model number, temperature, humidity, etc.
- Parts marked by "©" are not always kept in stock. Their delivery time may be longer than usual or they may be unavailable.

## Parts List of Exterior

Mark	No.	Part No.	Description	Mark	No.	Part No.	Description
	1	AWZ1885	TONE assembly		36	ABN-065	Nut
	2	AWZ1890	AF complex assembly	$\Delta$	37	ADG1019	AC power cord
$\Delta\star\star$	3	2SA1302	Transistor (Q3, Q4)		38	NK70FUC	Nut
$\Delta\star\star$	4	2SC3281	Transistor (Q1, Q2)		39	NK90FUC	Nut
	5	RDR $\frac{1}{4}$ PM6R8J	Carbon resistor (R1)		40	VMZ30P060FCU	Screw
	6	CQMXA104J100	Capacitor (C1)		41	AZN1746	Bonnet
$\Delta \star$	7	ATS1137	Power transformer (T1 AC220/240V)		42	AMR1161	Joint arm
$\star\star$	8	ASU1012	Remote slide switch (REC SELECTOR : S2)		101		PHONO AMP assembly
$\star\star$	9	ASU1014	Remote slide switch (INPUT SELECTOR : S1)		102		HEAD PHONE assembly
$\Delta\star\star$	10	AEK-403	Fuse (FU1 T2.5A)		103		LED assembly
	11	AMR1350	Insulator assembly		104		Terminal (GND)
	12	AMR1353	Insulator assembly		105		Chassis
	13	AAB1064	Knob (VOLUME)		106		Rear panel
	14	AAB1066	Knob (REC SELECTOR, INPUT SELECTOR)		107		Bottom plate
	15	AAB1068	Knob (BASS, TREBLE, BALANCE)		108		Switch holder
	16	AAD-418	Knob B (SPEAKERS)		109		Heat sink
	17	AAD1162	Knob (SUBSONIC, LOUDNESS, DIRECT)		110		.....
	18	AAD1343	Knob (POWER)		111		Nylon rivet
	19	AAD1366	Knob C (MUTING, PHONO SELECTOR)		112		Spacer
	20	AAM-030	Name plate		113		TRANSISTOR assembly
	21	AMB1334	Panel base		114		Speaker switch assembly
	22	AMR1160	LED lens				
	23	ANB1180	Front panel				
	24	ABH-052	Coil spring B				
	25	ABH1034	Coil spring B				
$\Delta$	26	AEC-882	Strain relief				
	27	AEE1014	Mica sheet				
	28	AKM1019	Pin jack joint				
	29	ABA-297	Screw M4 $\times$ 0.7				
	30	ABA-298	Screw				
	31	ABA1009	Screw				
	32	ABA1011	Screw				
	33	ABA1034	Screw				
	34	ABA1048	Screw				
	35	ABA1050	Screw				

Exterior

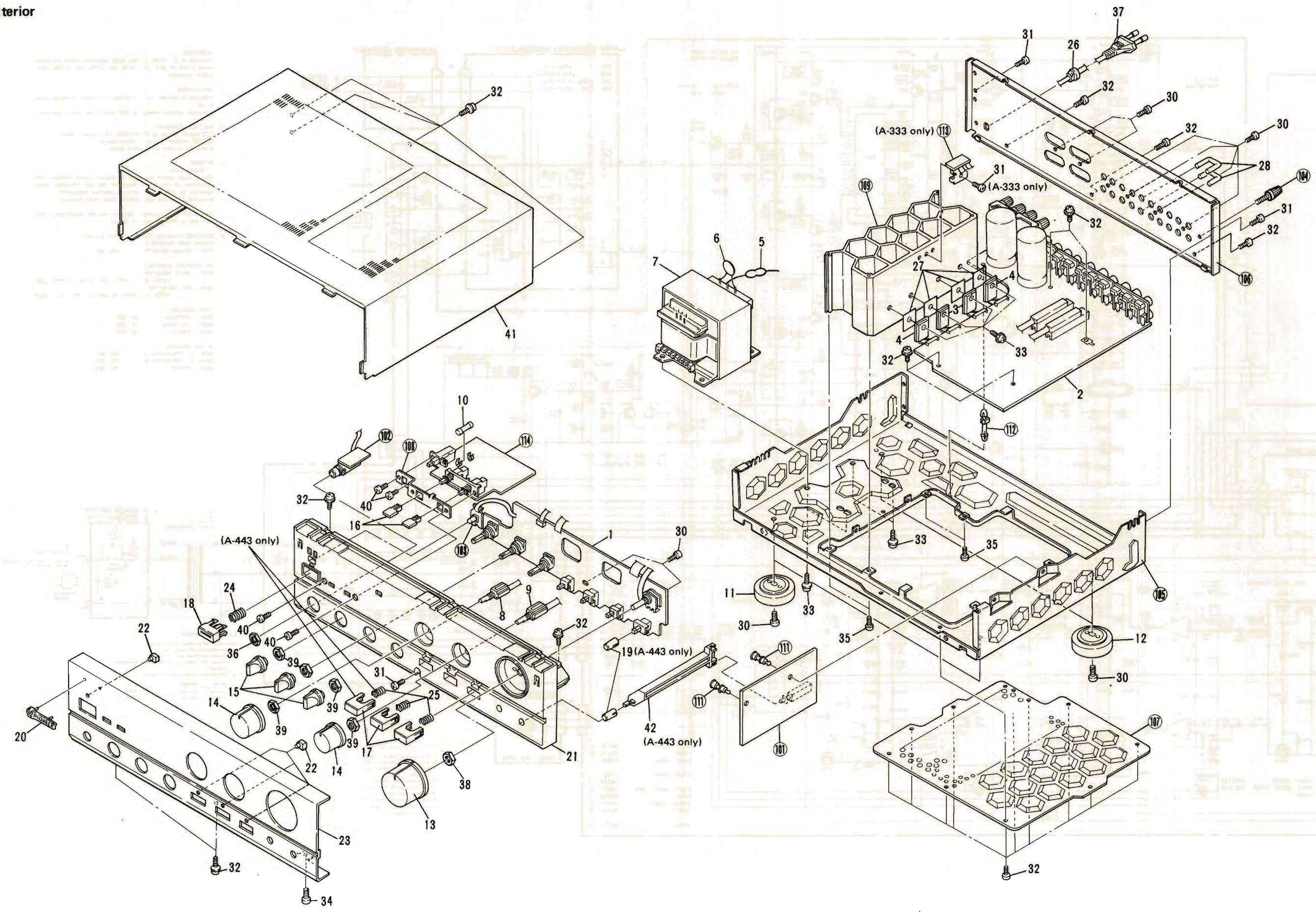

## 2. PACKING

### Part List

Mark	No.	Part No.	Description
	1	ARE1073	Operating instructions
	2	AHA1015	Front rear pad
	3	AHD1392	Packing case
	51		Packing seat

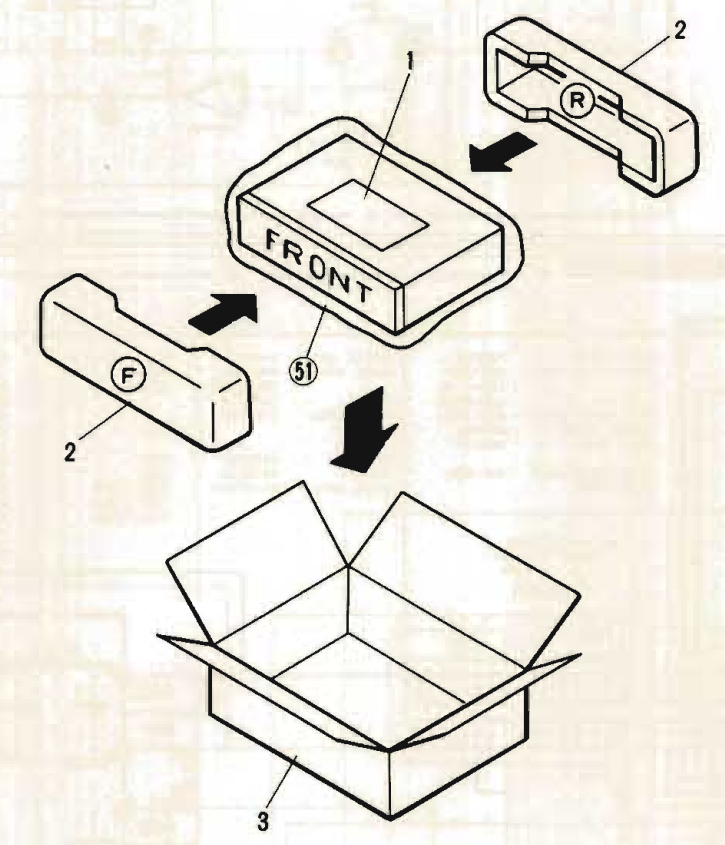

### 3. SCHEMATIC DIAGRAM

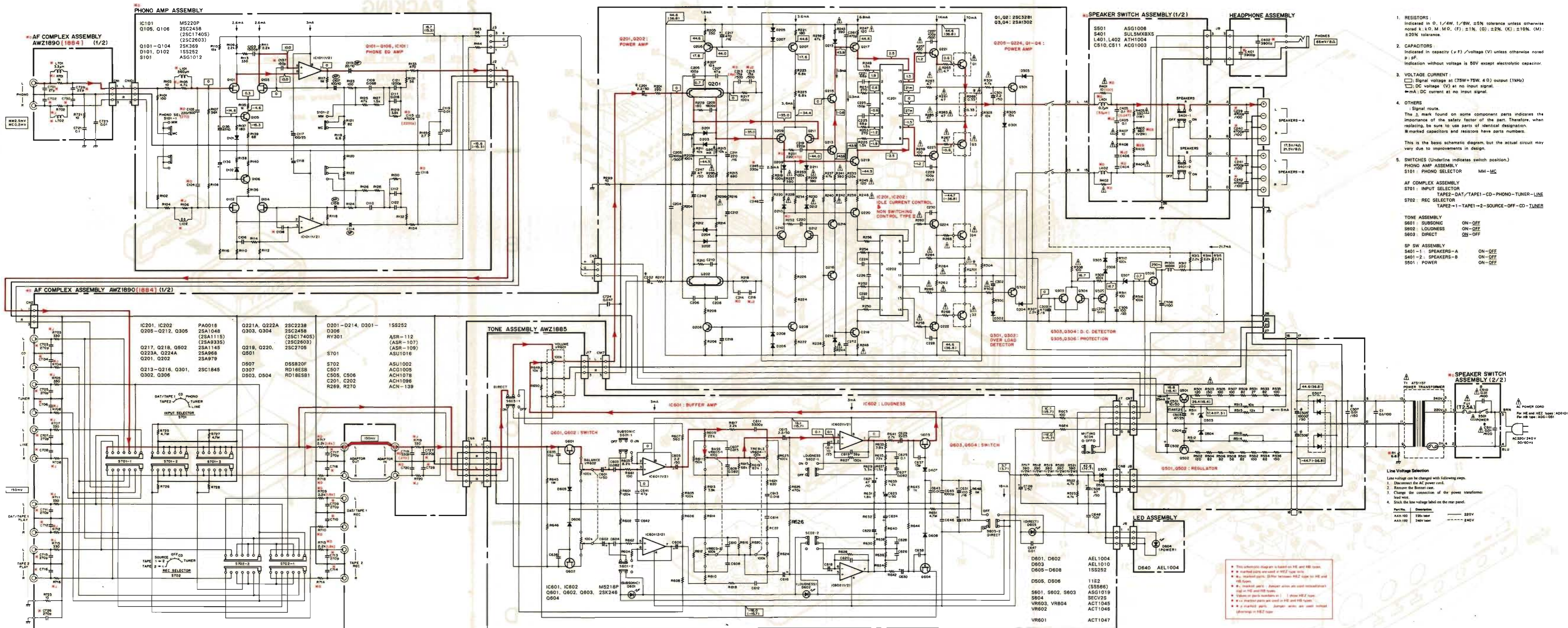

- RESISTORS:**  
Indicated in Ω, 1/4W, 1/8W, ±5% tolerance unless otherwise noted; k: kΩ, M: MΩ, (F): ±1%, (G): ±2%, (K): ±10%, (M): ±20% tolerance.
- CAPACITORS:**  
Indicated in capacity (μF) / voltage (V) unless otherwise noted; p: pF. Indication without voltage is 50V except electrolytic capacitor.
- VOLTAGE CURRENT:**  
□: Signal voltage at (75Ω+75Ω, 4Ω) output (1kHz)  
○: DC voltage (V) at no input signal.  
mA: DC current at no input signal.
- OTHERS:**  
Signal route.  
The Δ mark found on some component parts indicates the importance of the safety factor of the part. Therefore, when replacing, be sure to use parts of identical designation. Marked capacitors and resistors have parts numbers.  
This is the basic schematic diagram, but the actual circuit may vary due to improvements in design.
- SWITCHES:** (Underline indicates switch position.)  
PHONO AMP ASSEMBLY  
S101: PHONO SELECTOR MM-14C  
AF COMPLEX ASSEMBLY  
S701: INPUT SELECTOR TAPE2-DAT/TAPE1-CD-PHONO-TUNER-LINE  
S702: REC SELECTOR TAPE2-1-TAPE1-2-SOURCE-OFF-CD-TUNER

- |                    |        |  |
|--------------------|--------|--|
| SP SW ASSEMBLY     |        |  |
| S401-1: SPEAKERS-A | ON-OFF |  |
| S401-2: SPEAKERS-B | ON-OFF |  |
| S501: POWER        | ON-OFF |  |

- Line Voltage Selection**  
Line voltage can be changed with following steps:  
1. Disconnect the AC power cord.  
2. Remove the bottom case.  
3. Change the connection of the power transformer lead wire.  
4. Stick the line voltage label on the rear panel.
- |          |             |      |
|----------|-------------|------|
| Part No. | Description |      |
| AAA-192  | 720 volt    | 220V |
| AAA-193  | 720 volt    | 230V |
| AAA-194  | 720 volt    | 240V |

This schematic diagram is based on HE and HB type.  
\* Marked parts are used in HE2 type only.  
\* Marked parts (filter between HE2 type to HE and HB type).  
\* Marked parts (diagram) are used in HE2 type only.  
\* Values of parts numbers in [ ] show HE2 type.  
\* Marked parts are used in HE and HB type.  
\* Marked parts (diagram) are used in HE2 type only.

- |                  |              |
|------------------|--------------|
| D801, D802       | AEL1004      |
| D803             | AEL1010      |
| D805-D808        | 1SS252       |
| D505, D506       | 11E2 (S5568) |
| S601, S602, S603 | ASG1019      |
| S604             | SECV25       |
| VR603, VR604     | ACT1045      |
| VR602            | ACT1046      |
| VR601            | ACT1047      |

# 4. P.C. BOARDS CONNECTION DIAGRAM

● View from component side

NOTE

1. This P.C.B connection diagram is viewed from the parts mounted side.
2. The parts which have been mounted on the board can be replaced with those shown with the corresponding wiring symbols listed in the following Table.

P.C.B. pattern diagram indication	Corresponding part symbol	Part Name
		Transistor
		Radiator type transistor
		Diode
		Resistor
		Capacitor (Polarity)
		Capacitor (Non-polarity)

Others

P.C.B. pattern diagram indication	Part Name
IC	IC
S	Switch
RY	Relay
L	Coil
F	Filter
VR	Variable resistor or Semi-fixed resistor

3. The capacitor terminal marked with shows negative terminal.
4. The diode terminal marked with shows cathode side.
5. The transistor terminal to which E is affixed shows the emitter.

- marked parts: Differ between HEZ type to HE and HB types.
- This P.C. BOARDS CONNECTION DIAGRAM is based on HE and HB types.
- marked parts: In HE and HB types, jumper wires are mounted instead.
- marked parts: In HEZ type, jumper wires are mounted instead.
- marked parts: In HEZ type, jumper wires are mounted instead.

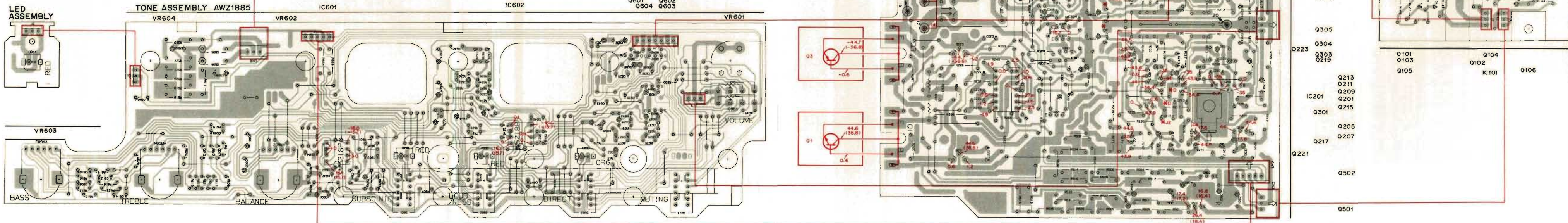

4. P.C. BOARD CONNECTION DIAGRAM

a View from component side

● View from soldering side

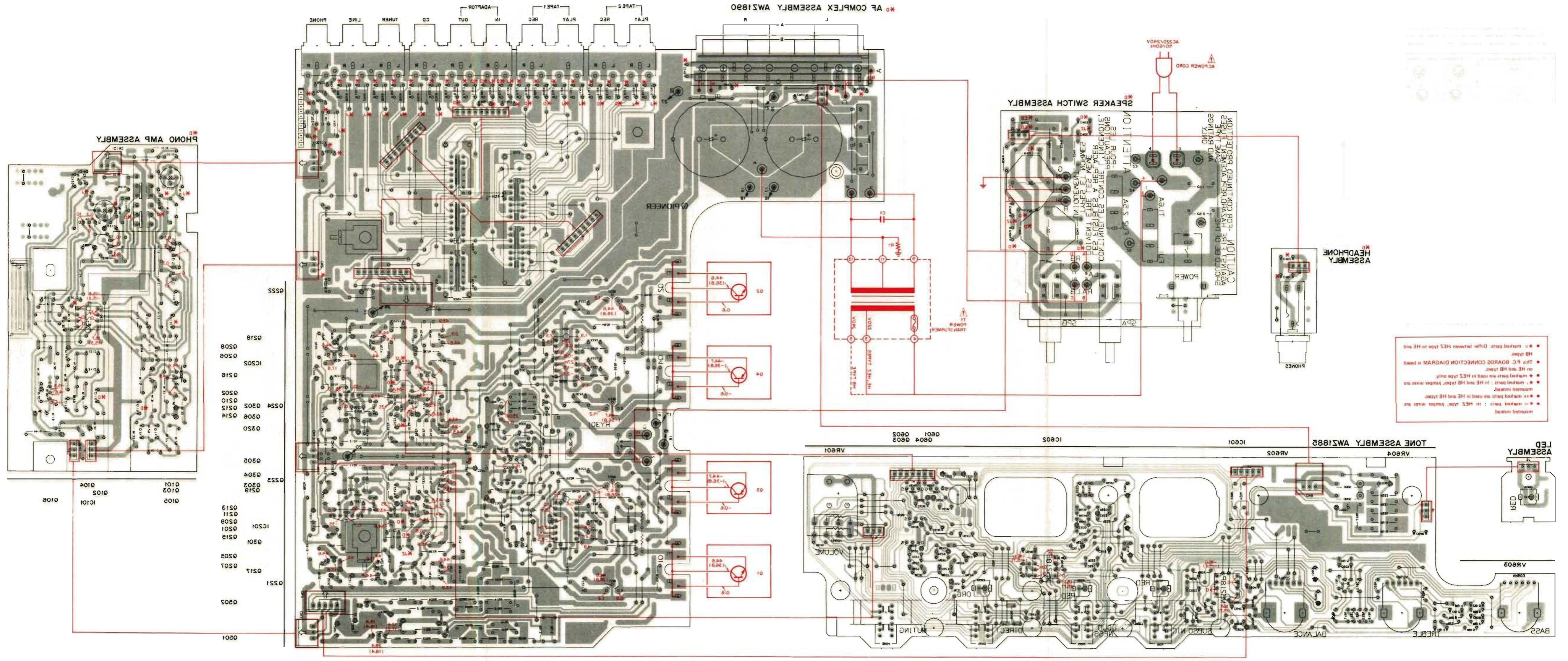

A

B

C

D

A

B

C

D

44-A

9

8

7

6

5

4

3

2

1

12

9

8

7

6

5

4

3

2

1

External appearance of transistors and ICs

2SA933S  
2SC1740S

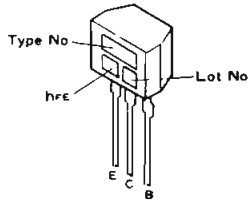

2SA1302  
2SA3281

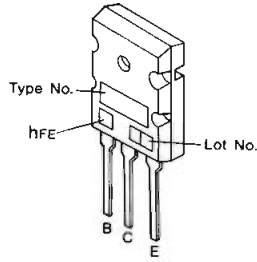

2SA1264N  
2SC3181N

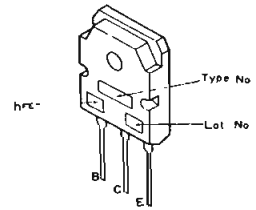

2SA968  
2SC2238

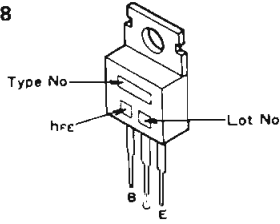

2SC1845

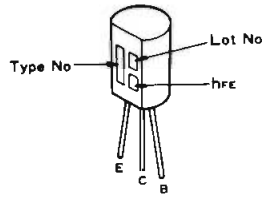

2SA979

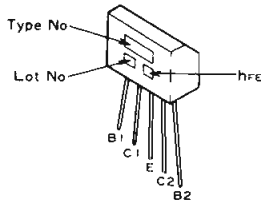

2SK246

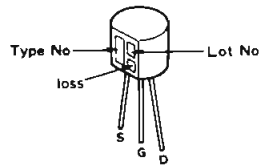

2SA1048  
2SC2458

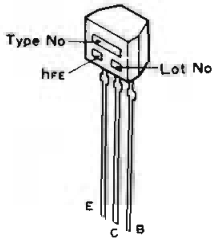

2SK369

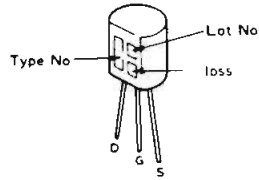

2SA1115  
2SC2603

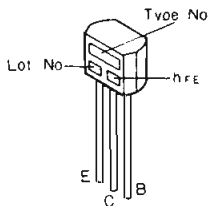

M5218P  
M5220P

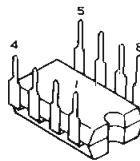

2SA1145  
2SC2705

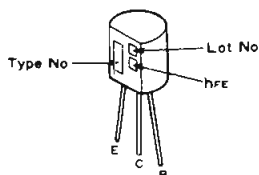

PA0016

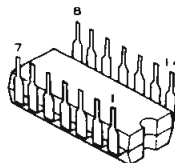

## 5. ELECTRICAL PARTS LIST

### NOTES :

- Parts without part number cannot be supplied.
- Parts marked by "⊙" are not always kept in stock. Their delivery time may be longer than usual or they may be unavailable.
- The  $\Delta$  mark found on some component parts indicates the importance of the safety factor of the part. Therefore, when replacing, be sure to use parts of identical designation.
- For your parts Stock Control, the fast moving items are indicated with the marks **★★** and **★**.  
**★★** GENERALLY MOVES FASTER THAN **★**.
- This classification shall be adjusted by each distributor because it depends on model number, temperature, humidity, etc.
- When ordering resistors, first convert resistance values into code form as shown in the following examples.

Ex.1 When there are 2 effective digits (any digit apart from 0), such as 560 ohm and 47k ohm (tolerance is shown by J=5%, and K=10%).

560 $\Omega$	56 $\times 10^1$	561	RD1/4PS	$\overline{561}$ J
47k $\Omega$	47 $\times 10^3$	473	RD1/4PS	$\overline{473}$ J
0.5 $\Omega$	0R5		RN2H	$\overline{0R5}$ K
1 $\Omega$	010		RS1P	$\overline{010}$ K

Ex.2 When there are 3 effective digits (such as in high precision metal film resistors).

5.62k $\Omega$	562 $\times 10^1$	5621	RN1/4SR	$\overline{5621}$ F
----------------	-------------------	------	---------	---------------------

### Miscellaneous Parts

#### P. C. BOARD ASSEMBLY

Mark	Symbol & Description	Part No.
	Tone assembly	AWZ1885
	AF Complex assembly	AWZ1890
	Phono amp assembly	
	Speaker switch assembly	
	Headphone assembly	
	LED assembly	

#### OTHERS

Mark	Symbol & Description	Part No.
<b>★★</b>	Q3, Q4	2SA1302
<b>★★</b>	Q1, Q2	2SC3281
	R1	RDR $\frac{1}{4}$ PM6R8J
	C1	QOMXA104J100
$\Delta$ <b>★</b>	T1 Power transformer (220V/240V)	ATS1137
<b>★★</b>	S2 Rotary switch (REC SELECTOR)	ASU1012
<b>★★</b>	S1 Rotary switch (INPUT SELECTOR)	ASU1014
$\Delta$ <b>★★★</b>	FU1 Fuse (T2.5A)	AEK-403
$\Delta$	AC Strain relief	AEC-882
$\Delta$	AC Power cord	ADG1019

#### Tone assembly (AWZ1885)

#### SEMICONDUCTORS

Mark	Symbol & Description	Part No.
<b>★★</b>	IC601, IC602	M5218P
<b>★★</b>	Q601, Q602, Q603, Q604	2SK246
<b>★</b>	D601, D602	AEL1004
<b>★</b>	D603	AEL1010
<b>★</b>	D605-D608	1SS252
<b>★</b>	D505, D506	11E2 (S5566)

#### SWITCHES

Mark	Symbol & Description	Part No.
<b>★★</b>	S601, S602, S603 Push switch (SUBSONIC, LOUDNESS, DIRECT)	ASG1019
<b>★★</b>	S604 Push switch (MUTING)	SECV2S

#### CAPACITORS

Mark	Symbol & Description	Part No.
	C635-C638	CCMSL150J50
	C619, C620	CCMSL390J50
	C641, C642	CCMSL470J50
	C509, C601, C602, C623, C624	CEAS010M50
	C617, C618, C629, C630	CEAS100M25
	C631, C632	CEAS101M16
	C605, C606, C615, C616	CEAS2R2M50
	C621, C622	CEAS470M10
	C508	CEAS470M50
	C603, C604	CFTXA823J50
	C611, C612	CGMYB332M25
	C643	CKCYB103K50 (CKDYB103K50)
	C647, C648	CKDYF103Z50
	C625, C626	CKDYX104M25
	C607, C608	CKDYX153M25
	C613, C614	CKDYX183M25
	C609, C610, C627, C628	CKDYX823M25
	C645, C646	CKDYB102K50

#### RESISTORS

Mark	Symbol & Description	Part No.
<b>★</b>	VR603, VR604 Variable resistor (BASS, TREBLE : 100k $\times$ 2)	ACT1045
<b>★</b>	VR602 Variable resistor (BALANCE : 100k $\times$ 2)	ACT1046
<b>★</b>	VR601 Variable resistor (VOLUME : 100k $\times$ 2)	ACT1047
	R517-R523	RD $\frac{1}{2}$ PM□□□J
	R663, R664, R651	RD $\frac{1}{4}$ PM□□□J
	Other resistors	RD $\frac{1}{8}$ PM□□□J



## AF complex assembly (AWZ1890)

## SEMICONDUCTORS

Mark	Symbol & Description	Part No.
★★	IC201, IC202	PA0016
★★	Q205-Q212, Q305	2SA1048 (2SA1115) (2SA933S)
★★	Q217, Q218, Q502	2SA1145
★★	Q223, Q224	2SA968
★★	Q201, Q202	2SA979
★★	Q213-Q216, Q301, Q302, Q306	2SC1845
★★	Q221, Q222	2SC2238
★★	Q303, Q304	2SC2458 (2SC1740S) (2SC2603)
★★	Q219, Q220, Q501	2SC2705
★	D507	D5SB20F
★	D307	RD16ESB
★	D503, D504	RD18ESB1
★	D201-D214, D301-D306	1SS252

## SWITCHES AND RELAY

Mark	Symbol & Description	Part No.
★★	RY301 Relay (PROTECTION)	ASR-112 (ASR-107) (ASR-109)
★★	S701 Remote slid switch (INPUT SELECTOR)	ASU1016
★★	S702 Remote slid switch (REC SELECTOR)	ASU1002

## CAPACITORS

Mark	Symbol & Description	Part No.
	C507 (0.01/AC150)	ACG1005
	C505, C506 (10000/50)	ACH1078
	C201, C202 (2.2/50)	ACH1096
	C203, C204, C227-C230	CCCSL101K500 (CCDSL101K500)
	C213-C216	CCCSL150K500 (CCDSL150K500)
	C205, C206	CCMSL101J50
	C207, C208	CCMSL470J50
	C221-C224	CCMSL680J50
	C306	CEAS010M100
	C501, C502	CEAS100M50
	C305	CEAS101M25
	C301, C302	CEAS2R2M50
	C503, C504	CEAS470M25
	C247, C248	CEAS470M50
	C217, C218, C303	CEAS471M6
	C211, C212	CEYA221M16
	C209, C210	CKCYB182K50 (CKDYB182K50)
	C304, C725	CKCYF103Z50 (CKDYF103Z50)
	C721	CKCYX104M25 (CKDYX104M25)
	C724	CKDYF473Z50

Mark	Symbol & Description	Part No.
	C225, C226	CKMYB151K50
	C219, C220	CKMYB221K50
	C719, C720	CKMYB331K50
	C261, C262	CKMYB471K50

## RESISTORS

Mark	Symbol & Description	Part No.
⚠	R269, R270 Wire wound (0.33 Ω × 2/5W)	ACN-139
⚠	R201-R204, R215-R218	RDR¼PM□□□J
⚠	R503	RD¼PMFL151J
⚠	R227-R230, R257-R268, R301, R302, R283-R286, R295, R296, R308	RD¼PMF□□□J
	R723, R309, R310, R316, R307, R709, R710, R713, R714, R717, R718, R725-R728	RD¼PM□□□J
⚠	R241-R248	RFA¼PS□□□J
	Other resistors	RD¼PM□□□J

## OTHERS

Mark	Symbol & Description	Part No.
	Terminal 4P (TAPE2, ADAPTOR)	AKB1007
	Terminal 6P (PHONO, CD, TUNER)	AKB1008
	Terminal 6P (LINE, TAPE1)	AKB1024
	Terminal 8P (SPEAKER)	AKE1011

## Phono Amp Assembly

## SEMICONDUCTORS

Mark	Symbol & Description	Part No.
★★	IC101	M5220P
★★	Q105, Q106	2SC2458 (2SC1740S) (2SC2603)
★★	Q101-Q104	2SK369
★	D101, D102	1SS252

## SWITCHES

Mark	Symbol & Description	Part No.
★★	S101 Push switch (MM-MC)	ASG1012

## CAPACITORS

Mark	Symbol & Description	Part No.
	C103, C104	CCCSL221K500 (CCDSL221K500)
	C107, C108	CEANP101M10
	C113, C114	CEANP220M10
	C117, C118	CEAS101M25
	C135, C136	CEAS470M10
	C111, C112	CFTXA183J50
	C109, C110	CFTXA683J50
	C119, C120	CKCYF103Z50 (CKDYF103Z50)
	C105, C106	CKMYB152K50
	C121, C122	CQMA122J50
	C115, C116	CQMA472K50

**RESISTORS**

<u>Mark</u>	<u>Symbol &amp; Description</u>	<u>Part No.</u>
	R101, R102, R107, R108, R119-R122, R133, R134	RDR $\frac{1}{4}$ PM□□□J
	R104, R103	RDR $\frac{1}{6}$ PU100J
	R145	RD $\frac{1}{8}$ PM2R7J
	Other resistors	RD $\frac{1}{4}$ PM□□□J

**Speaker Switch Assembly**

**SWITCHES**

<u>Mark</u>	<u>Symbol &amp; Description</u>	<u>Part No.</u>
△	S501 Push switch (POWER)	ASG1006
	S401 Push switch (SP. A-B)	SUL5MXBXS

**COILS**

<u>Mark</u>	<u>Symbol &amp; Description</u>	<u>Part No.</u>
	L401, L402 AF choke coil (0.7 $\mu$ H)	ATH1004

**CAPACITORS**

<u>Mark</u>	<u>Symbol &amp; Description</u>	<u>Part No.</u>
△	C510, C511 (0.01 $\mu$ F/400V)	ACG1003
△	C403-C406	CFTXA104J50

**RESISTORS**

<u>Mark</u>	<u>Symbol &amp; Description</u>	<u>Part No.</u>
	R405, R406	RD $\frac{1}{2}$ PM681J
△	R401, R402, R407, R408	RD $\frac{1}{4}$ PMFL100J
△	R403, R404	RS1LMF331J

**Headphone Assembly**

**OTHERS**

<u>Mark</u>	<u>Symbol &amp; Description</u>	<u>Part No.</u>
	Jack (PHONES)	AKN1002

**LED Assembly**

**SEMICONDUCTORS**

<u>Mark</u>	<u>Symbol &amp; Description</u>	<u>Part No.</u>
★	D640 LED assembly	AEL1004

## 6. FOR A-443/HB, HEZ AND A-443-S/HEZ TYPES

NOTES :

- Parts without part number cannot be supplied.
- The  $\Delta$  mark found on some component parts indicates the importance of the safety factor of the part. Therefore, when replacing, be sure to use parts of identical designation.
- For your parts Stock Control, the fast moving items are indicated with the marks  $\star\star$  and  $\star$ .  
 $\star\star$  GENERALLY MOVES FASTER THAN  $\star$ .  
 This classification shall be adjusted by each distributor because it depends on model number, temperature, humidity, etc.
- Parts marked by "⊙" are not always kept in stock. Their delivery time may be longer than usual or they may be unavailable.

The A-443/HB, HEZ and A-443-S/HEZ types are the same as the A-443/HE type with the exception of the following sections.

Mark	Symbol & Description	Part No.				Remarks
		A-443 HE type	A-443 HB type	A-443 HEZ type	A-443-S HEZ type	
$\Delta$ $\Delta\star\star$	AF complex assembly	AWZ1890	AWZ1890	AWZ1884	AWZ1884	
	Phono amp assembly	Non supply	Non supply	Non supply	Non supply	
	Speaker switch assembly	Non supply	Non supply	Non supply	Non supply	
	AC power cord	ADG1019	ADG-051	ADG1019	ADG1019	
	FU1 Fuse (T2.5A/250V)	AEK-403	AEK-512	AEK-403	AEK-403	
	Headphone assembly	Non supply	Non supply	Non supply	Non supply	
	Knob (VOLUME)	AAB1064	AAB1064	AAB1064	AAB1065	
	Knob (REC SELECTOR, INPUT SELECTOR)	AAB1066	AAB1066	AAB1066	AAB1067	
	Knob (BASS, TREBLE, BALANCE)	AAB1068	AAB1068	AAB1068	AAB1069	
	Knob B (SPEAKERS A, B)	AAD-418	AAD-418	AAD-418	AAD1368	
	Knob (SUBSONIC, LOUDNESS, DIRECT)	AAD1162	AAD1162	AAD1162	AAD1163	
	Knob C (MUTING, PHONO SELECTOR)	AAD1366	AAD1366	AAD1366	AAD1367	
	Knob (POWER)	AAD1343	AAD1343	AAD1343	AAD1344	
	Packing case	AHD1392	AHD1392	AHD1392	AHD1412	
	Panel base	AMB1334	AMB1334	AMB1334	AMB1335	
	Front panel	ANB1180	ANB1180	ANB1180	ANB1181	
	R1 Carbon resistor (6.8 $\Omega$ )	.....	.....	RD $\frac{1}{4}$ PM6R8J	RD $\frac{1}{4}$ PM6R8J	
Operating instructions (English, German, French, Italian, Dutch, Swedish, Spanish, Portuguese)	ARE1073	.....	.....	.....		
(German)	.....	.....	ARC1077	ARC1077		
(English)	.....	ARB1102	.....	.....		
Screw	.....	.....	BBT30P060FZK	ABA-274	For bonnet	
Bonnet	AZN1746	AZN1746	AZN1799	AZN1800		

**AF COMPLEX ASSEMBLY (AWZ1884)**

The AF complex assembly (AWZ1884) for HEZ type is the same as the AF complex assembly (AWZ1890) for HE and HB types with the exception of the following sections.

Mark	Symbol & Description	Part No.		Remarks
		AWZ1890 (HE and HB types)	AWZ1884 (HEZ type)	
	C215, C216 C213, C214	CCCSL150K500 CCCSL150K500	..... CCDSL080D500 (CCCSL080D500)	
	C239-C242 C245, C246 C701, C702	..... ..... .....	CQMXA472J100 CKMYB331K50 CCMSL270J50	
	C703-C718 C719, C720 C724	..... CKMYB331K50 CKDYF473Z50	CKMYB271K50 CKMYB271K50 CKCYF473Z50 (CKDYF473Z50)	
	C727, C728 C729, C730	..... .....	CKMYB221K50 CCMSL220J50	
	C726 R231, R232 R701, R702 R703, R704 R705-R708	..... RD 1/4 PM221J ..... ..... .....	CKMYB271K50 RD 1/4 PM471J RD 1/4 PM102J RDR 1/4 PPM331J RD 1/4 PM331J	
	R709, R710, R713, R714, R717, R718 R711, R712, R715, R716, R719, R720 L701, L702	RD 1/4 PM222J ..... .....	RD 1/4 PM182J RD 1/4 PM331J LAU3R3K	

**PHONO AMP ASSEMBLY**

The phono amp assembly (for HEZ type) is the same as the phono amp assembly (for HE and HB types) with the exception of the following sections.

Mark	Symbol & Description	Part No.		Remarks
		For HE and HB types	For HEZ type	
	C103, C104	CCCSL221K500	CCDSL271K500 (CCCSL271K500)	
	C115, C116 C137, C138 L101, L102 Coil (560 μ H) R105, R106	CQMA472K50 ..... ..... .....	CQMA222K50 CKMYB151K50 ATH1024 RD 1/4 PM472J	

**SPEAKER SWITCH ASSEMBLY**

The Speaker switch assembly (for HEZ type) is the same as the Speaker switch assembly (for HE and HB types) with the exception of the following sections.

Mark	Symbol & Description	Part No.		Remarks
		For HE and HB types	For HEZ type	
	C403, C404 C405, C406 L401, L402 AF choke coil R401, R402 R405, R406	CFTXA104J50 CFTXA104J50 ATH1004 RD $\frac{1}{2}$ PMFL100J RD $\frac{1}{2}$ PM681J	CFTXA473J50 ..... ATH1009 RD $\frac{1}{2}$ PMFL101J .....	

**HEADPHONE ASSEMBLY**

The Headphone assembly (for HEZ type) is the same as the Headphone assembly (for HE and HB types) with the exception of the following sections.

Mark	Symbol & Description	Part No.		Remarks
		For HE and HB types	For HEZ type	
	C401, C402	.....	CKCYB392K50	

## 7. FOR A-333/HE, HB, HEZ AND A-333-S/HEZ TYPES

The A-333/HE, HB, HEZ and A-333-S/HEZ types are the same as the A-443/HE type with the exception of the following sections.

Mark	Symbol & Description	Part No.				
		A-443 HE type	A-333 HE type	A-333 HB type	A-333 HEZ type	A-333-S HEZ type
⊥ ★	AF complex assembly	AWZ1890	AWZ1898	AWZ1898	AWZ1894	AWZ1894
	Phono amp assembly	Non supply	Non supply	Non supply	Non supply	Non supply
	Speaker switch assembly	Non supply	Non supply	Non supply	Non supply	Non supply
	Tone assembly	AWZ1885	AWZ1895	AWZ1895	AWZ1895	AWZ1895
	T1 Power transformer (220/240V)	ATS1137	ATS1138	ATS1138	ATS1138	ATS1138
⊥★★	Transistor assembly	.....	Non supply	Non supply	Non supply	Non supply
	Headphone assembly	Non supply	Non supply	Non supply	Non supply	Non supply
	FU1 Fuse (T2.5A/250V)	AEK-403	.....	.....	.....	.....
⊥★★	FU1 Fuse (T1.6A/250V)	.....	AEK-405	AEK-510	AEK-405	AEK-405
★★	C1	CQMXA104J100	CQMXA473J100	CQMXA473J100	CQMXA473J100	CQMXA473J100
	R1	.....	.....	.....	RD¼PM6R8J	RD¼PM6R8J
★★	Q3, Q4	2SA1302	2SA1264N	2SA1264N	2SA1264N	2SA1264N
★★	Q1, Q2	2SC3281	2SC3181N	2SC3181N	2SC3181N	2SA3181N
	Knob B (SPEAKERS)	AAD-418	AAD-418	AAD-418	AAD-418	AAD1368
	Knob (SUBSONIC)	AAD1162	.....	.....	.....	.....
	Knob (LOUDNESS, DIRECT)	AAD1162	AAD1162	AAD1162	AAD1162	AAD1163
	Knob C (MUTING, PHONO SELECTOR)	AAD1366	.....	.....	.....	.....
	Knob (POWER)	AAD1343	AAD1343	AAD1343	AAD1343	AAD1344
	Joint arm	AMR1161	.....	.....	.....	.....
	Front panel	ANB1180	ANB1182	ANB1182	ANB1182	ANB1183
	Panel base	AMB1334	AMB1334	AMB1334	AMB1334	AMB1335
	Bonnet	AZN1746	AZN1746	AZN1746	AZN1799	AZN1800
	Screw (For bonnet)	.....	.....	.....	BBZ30P060FZK	ABA-274
	Screw (For heat sink)	ABA1050	.....	.....	.....	.....
	Packing case	AHD1392	AHD1393	AHD1393	AHD1393	AHD1413
	Knob (VOLUME)	AAB1064	AAB1064	AAB1064	AAB1064	AAB1065
	Knob (REC SELECTOR, INPUT SELECTOR)	AAB1066	AAB1066	AAB1066	AAB1066	AAB1067
	Knob (BASS, TREBLE, BALANCE)	AAB1068	AAB1068	AAB1068	AAB1068	AAB1069
	Operating instructions (English, German, French, Italian, Dutch, Swedish, Spanish, Portuguese)	ARE1073	ARE1073	ARE1073	.....	.....
	(English)	.....	.....	ARB1102	.....	.....
	(German)	.....	.....	.....	ARC1077	ARC1077
★★	S2 Rotary switch (REC SELECTOR)	ASU1012	ASU1013	ASU1013	ASU1013	ASU1013
★★	S1 Rotary switch (INPUT SELECTOR)	ASU1014	ASU1015	ASU1015	ASU1015	ASU1015
⊥	AC power cord	ADG1019	ADG1019	ADG-051	ADG1019	ADG1019

## 7.1 ELECTRICAL PARTS LIST OF A-333/HE, HB AND HEZ types

### • For A-333/HE and HB types

#### NOTES :

- Parts without part number cannot be supplied.
- Parts marked by "⊙" are not always kept in stock. Their delivery time may be longer than usual or they may be unavailable.
- The  $\Delta$  mark found on some component parts indicates the importance of the safety factor of the part. Therefore, when replacing, be sure to use parts of identical designation.
- For your parts Stock Control, the fast moving items are indicated with the marks **★★** and **★**.  
**★★ GENERALLY MOVES FASTER THAN ★.**
- This classification shall be adjusted by each distributor because it depends on model number, temperature, humidity, etc.
- When ordering resistors, first convert resistance values into code form as shown in the following examples.

Ex.1 When there are 2 effective digits (any digit apart from 0), such as 560 ohm and 47k ohm (tolerance is shown by J=5%, and K=10%).

560 $\Omega$	56 $\times$ 10 <sup>1</sup>	561	RD1/4PS	561J
47k $\Omega$	47 $\times$ 10 <sup>3</sup>	473	RD1/4PS	473J
0.5 $\Omega$	0R5		RN2H	0R5K
1 $\Omega$	010		RS1P	010K

Ex.2 When there are 3 effective digits (such as in high precision metal film resistors).

5.62k $\Omega$	562 $\times$ 10 <sup>1</sup>	5621	RN1/4SR	5621F
----------------	------------------------------	------	---------	-------

### Miscellaneous Parts

#### P. C. BOARD ASSEMBLIES

Mark	Symbol & Description	Part No.
	Tone assembly	AWZ1895
	AF complex assembly	AWZ1898
	Phono amp assembly	
	Transistor assembly	
	Speaker switch assembly	
	Headphone assembly	
	LED assembly	

#### OTHERS

Mark	Symbol & Description	Part No.
$\Delta$ ★★	Q3, Q4	2SA1264N
$\Delta$ ★★	Q1, Q2	2SC3181N
	C1	QOMXA473J100
$\Delta$ ★	T1 Power transformer (AC220/240V)	ATS1138
★★	S2 Rotary switch (REC SELECTOR)	ASU1013
★★	S1 Rotary switch (INPUT SELECTOR)	ASU1015
$\Delta$ ★★	FU1 Fuse (T1.6A/250V)	AEK-405
$\Delta$	Stain relief	AEC-882
$\Delta$	AC Power cord	ADG1019

### Tone Assembly (AWZ1895)

#### SEMICONDUCTORS

Mark	Symbol & Description	Part No.
★★	IC601, IC602	M5218P
★★	Q601-Q604	2SK246
★	D602	AEL1004
★	D603	AEL1010
★	D605-D608	1SS252
★	D505, D506	11E2 (S5566)

#### SWITCHES

Mark	Symbol & Description	Part No.
★★	S602, S603 Push switch (LOUDNESS, DIRECT)	ASG1019

#### CAPACTIORS

Mark	Symbol & Description	Part No.
	C635-C638	CCMSL150J50
	C619, C620	CCMSL390J50
	C641, C642	CCMSL470J50
	C509, C601, C602, C623, C624	CEAS010M50
	C617, C618, C629, C630	CEAS100M25
	C631, C632	CEAS101M16
	C605, C606, C615, C616	CEAS2R2M50
	C621, C622	CEAS470M10
	C508	CEAS470M50
	C611, C612	CGMYB332M25
	C643	CKCYB103K50 (CKDYB103K50)
	C625, C626	CKDYX104M25
	C607, C608	CKDYX153M25
	C613, C614	CKDYX183M25
	C609, C610, C627, C628	CKDYX823M25
	C645, C646	CKMYB102K50
	C633, C634	CKMYB561K50

**RESISTORS**

Mark	Symbol & Description	Part No.
★	VR603, VR604 Variable resistor (BASS, TREBLE : 100k×2)	ACT1045
★	VR602 Variable resistor (BALANCE : 100k×2)	ACT1046
★	VR601 Variable resistor (VOLUME : 100k×2)	ACT1047
	R517 - R521	RD½PM331J
	R522, R523, R651, R663, R664	RD¼PM□□□J
	Other resistors	RD⅛PM□□□J

**AF Complex Assembly (AWZ1898)**

**SEMICONDUCTORS**

Mark	Symbol & Description	Part No.
★★	Q205, Q206, Q305	2SA1048 (2SA1115)
★★	Q217, Q218	2SA1145
★★	Q223, Q224	2SA968
★★	Q201, Q202	2SA979
★★	Q301, Q302, Q306	2SC1845
★★	Q221, Q222	2SC2238
★★	Q203, Q204, Q303, Q304	2SC2458
★★	Q219, Q220	2SC2705
★	D507	D5SB20F
★	D307	RD16ESB
★	D501, D502	RD16ESB3
★	D205 - D208, D221, D222, D301 - D306	1SS252

**SWITCH AND RELAY**

Mark	Symbol & Description	Part No.
★	RY301 Relay (PROTECTION)	ASR - 112 (ASR - 107) (ASR - 109)
★★	S702 Slide switch (INPUT SELECTOR)	ASU1002
★★	S701 Slide switch (REC SELECTOR)	ASU1016

**CAPACITORS**

Mark	Symbol & Description	Part No.
	C507 (0.01 μ F / 150V)	ACG1005
	C505, C506 (6800 μ F / 42V)	ACH1077
	C249, C250	CCCSL100D500 (CCDSL100D500)
	C227 - C230	CCCSL101K500 (CCDSL101K500)
	C209, C210	CCCSL221J50 (CCDSL221J50)
	C203 - C206	CCMSL101J50
	C213 - C216	CCMSL150J50
	C207, C208	CCMSL470J50
	C306	CEAS010M100
	C724	CEAS010M50

Mark	Symbol & Description	Part No.
	C233, C234	CEAS100M50
	C263, C264	CEAS101M10
	C305	CEAS101M25
	C301, C302	CEAS2R2M50
	C501, C502	CEAS470M25
	C217, C218, C303	CEAS471M6
	C201, C202	CEYA2R2M50
	C211, C212	CEYA221M16
	C251, C252	CKCYB272K50 (CKDYB272K50)
	C304	CKCYF103Z50 (CKDYF103Z50)
	C721	CKCYX104M25 (CKDYX104M25)
	C231, C232 C719, C720	CKMYB122K50 CKMYB331K50

**RESISTORS**

Mark	Symbol & Description	Part No.
△	R269, R270 (0.33 Ω × 2)	ACN - 139
	R201 - R204, R215 - R218	RDR¼PM□□□J
△	R205, R206, R247, R248, R261 - R264, R301, R302, R308	RD¼PMF□□□J
	R291, R292, R307, R309, R310, R316, R709, R710, R713, R714, R717, R718, R723, R725 - R728	RD⅛PM□□□J
⌋	R245, R246, R257 - R260	RFA¼PS101J
⌋	R265 - R268 R275, R276	RFA¼PS4R7J RN¼PQ1501F
	Other resistors	RD¼PM□□□J

**OTHERS**

Mark	Symbol & Description	Part No.
	Terminal 4P (TAPE2, ADAPTOR)	AKB1007
	Terminal 6P (PHONO, CD, TUNER)	AKB1008
	Terminal 6P (LINE, TAPE1)	AKB1024
	Terminal 8P (SPEAKER)	AKE1011

**Phono Amp Assembly**

**SEMICONDUCTORS**

Mark	Symbol & Description	Part No.
★★	IC101	M5220P

**CAPACITORS**

Mark	Symbol & Description	Part No.
	C107, C108	CEAS101M10
	C117, C118	CEAS101M25
	C113, C114	CEAS4R7M50
	C111, C112	CFTXA183J50
	C109, C110	CFTXA683J50
	C123, C124 C119, C120	CEAS100M50 CKCYF103Z50 (CKDYF103Z50)
	C103, C104 C121, C122 C115, C116	CKMYB221K50 CQMA122J50 CQMA472K50



**RESISTORS**

Mark	Symbol & Description	Part No.
	R133, R134, R121, R122 R103, R104, R141, R142 R145 Other resistors	RDR $\frac{1}{4}$ PM□□□J RDR $\frac{1}{4}$ PU□□□J RD $\frac{1}{4}$ PM2R7J RD $\frac{1}{4}$ PM□□□J

**Transistor Assembly**

**SEMICONDUCTORS**

Mark	Symbol & Description	Part No.
★★	Q225, Q226	2SC2603

**Speaker switch Assembly**

**SWITCHES**

Mark	Symbol & Description	Part No.
△★★	S501 Push switch (POWER)	ASG1006
★★	S401 Push switch (SPEAKERS)	SUL5MXBXS

**COILS**

Mark	Symbol & Description	Part No.
	L401, L402 AF choke coil (0.7 $\mu$ H)	ATH1004

**CAPACITORS**

Mark	Symbol & Description	Part No.
△	C501, C511 (0.01 $\mu$ F / 400V) C403-C406	ACG1003 CFTXA104J50

**RESISTORS**

Mark	Symbol & Description	Part No.
△	R405, R406 R401, R402, R407, R408 R403, R404	RD $\frac{1}{4}$ PM681J RD $\frac{1}{4}$ PMFL100J RS1LMF331J

**Headphone Assembly**

**OTHERS**

Mark	Symbol & Description	Part No.
	Jack (PHONES)	AKN1002

**LED Assembly**

**SEMICONDUCTOR**

Mark	Symbol & Description	Part No.
★	D604 LED assembly	AEL1004

• For A-333/HEZ and A-333-S/HEZ types.

**AF COMPLEX ASSEMBLY (AWZ1894)**

The AF complex assembly (AWZ1894) for HEZ type is the same as the AF complex assembly (AWZ1898) for HE and HB types with the exception of the following sections.

Mark	Symbol & Description	Part No.		Remarks
		AWZ1898 (HE and HB types)	AWZ1894 (HEZ type)	
	C215, C216 C213, C214 C239-C242 C245, C246 C249, C250	CCDSL150K500 CCDSL150K500 ..... ..... CCCSL100D500	..... CCDSL080D500 CQMXA472J100 CKMYB331K50 CCCSL050C500	
	C251, C252 C701, C702 C703-C718 C719, C720 C726	CKCYB272K50 ..... ..... CKMYB331K50 .....	..... CCMSL680J50 CKMYB271K50 CKMYB271K50 CCMSL121J50	
	C727, C728 R209, R210 R291, R292 R703-R708 R709, R710, R713, R714, R717, R718 R711, R712, R715, R716, R719, R720	..... RD $\frac{1}{4}$ PM471J RD $\frac{1}{4}$ PM330J ..... RD $\frac{1}{4}$ PM222J .....	CKMYB221K50 RD $\frac{1}{4}$ PM221J ..... RD $\frac{1}{4}$ PM331J RD $\frac{1}{4}$ PM182J RD $\frac{1}{4}$ PM331J	

**PHONO AMP ASSEMBLY**

The phono amp assembly (for HEZ type) is the same as the phono amp assembly (for HE and HB types) with the exception of the following sections.

Mark	Symbol & Description	Part No.		Remarks
		For HE and HB types	For HEZ type	
	C115, C116 L103-L106 Inductor R105, R106	CQMA472K50 ..... .....	CQMA222K50 LAU221K RD $\frac{1}{4}$ PM332J	

**SPEAKER SWITCH ASSEMBLY**

The Speaker switch assembly (for HEZ type) is the same as the Speaker switch assembly (for HE and HB types) with the exception of the following sections.

Mark	Symbol & Description	Part No.		Remarks
		For HE and HB types	For HEZ type	
	C403, C404 C405, C406 L401, L402 AF choke coil R401, R402 R405, R406	CFTXA104J50 CFTXA104J50 ATH1004 RD $\frac{1}{4}$ PMFL100J RD $\frac{1}{4}$ PM681J	CFTXA473J50 ..... ATH1009 RD $\frac{1}{4}$ PMFL101J .....	

**HEADPHONE ASSEMBLY**

The Headphone assembly (for HEZ type) is the same as the Headphone assembly (for HE and HB types) with the exception of the following sections.

Mark	Symbol & Description	Part No.		Remarks
		For HE and HB types	For HEZ type	
	C401, C402	.....	CKCYB392K50	

7.2 SCHEMATIC DIAGRAM

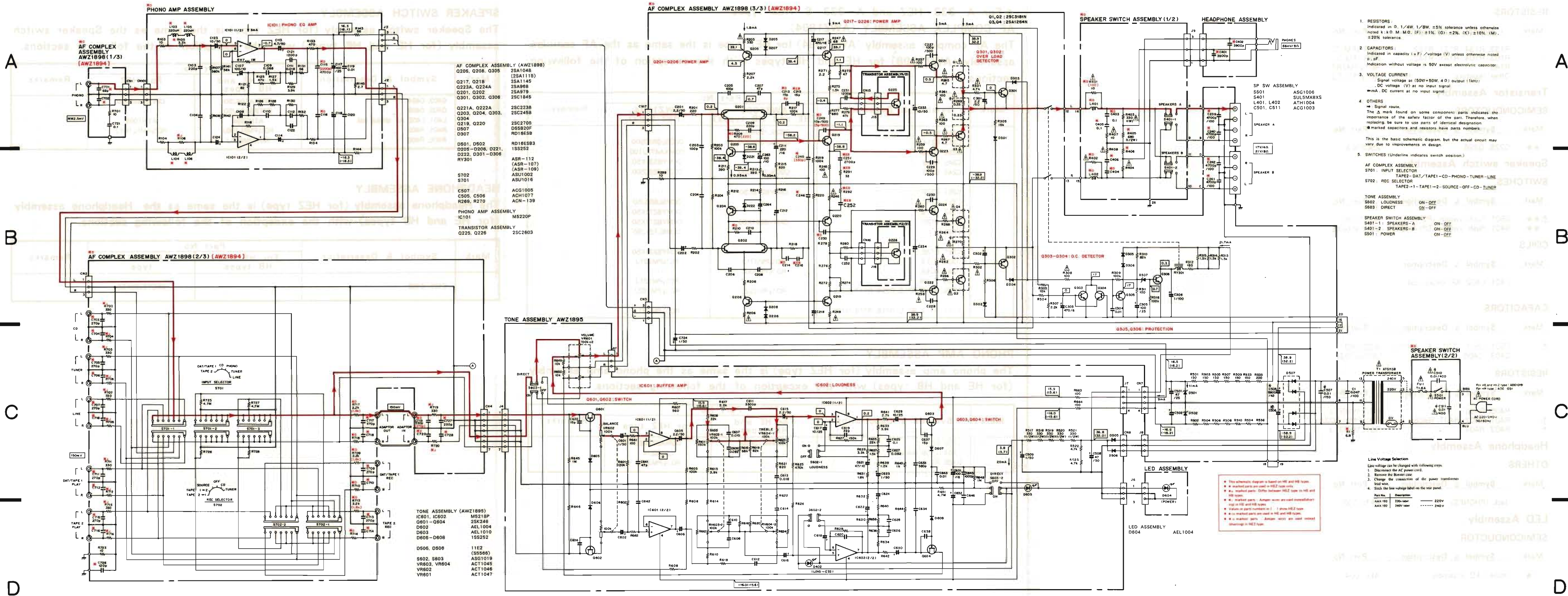

- RESISTORS:**  
Indicated in Ω, 1/4W, 1/2W, ±5% tolerance unless otherwise noted. L: O.M.M.O. (F): ±1%, (G): ±10%, (M): ±20% tolerance.
  - CAPACITORS:**  
Indicated in capacity (μF) / voltage (V) unless otherwise noted. P, pf. Indication without voltage is 50V except electrolytic capacitor.
  - VOLTAGE CURRENT:**  
Signal voltage at (50Ω±50Ω, 4Ω) output (1kHz).  
DC voltage (V) at no input signal.  
mA: DC current at no input signal.
  - OTHERS:**  
→ Signal route.  
The Δ mark found on some component parts indicates the importance of the safety factor of the part. Therefore, when replacing, be sure to use parts of identical designation. \*marked capacitors and resistors have parts numbers.  
This is the basic schematic diagram, but the actual circuit may vary due to improvements in design.
  - SWITCHES** (Underline indicates switch position.)
- AF COMPLEX ASSEMBLY**  
S701: INPUT SELECTOR  
TAPE2-DAT/TAPE1-CD-PHONO-TUNER-LINE  
S702: REC SELECTOR  
TAPE2-1-TAPE1-2-SOURCE-OFF-CD-TUNER
- TONE ASSEMBLY**  
S602: LOUDNESS ON-OFF  
S603: DIRECT ON-OFF
- SPEAKER SWITCH ASSEMBLY**  
S401-1: SPEAKERS-A ON-OFF  
S401-2: SPEAKERS-B ON-OFF  
S501: POWER ON-OFF

- Line Voltage Selection**  
Line voltage can be changed with following steps:  
1. Disconnect the AC power cord.  
2. Remove the Bottom Case.  
3. Change the connection of the power transformer.  
4. Stick the line voltage label on the rear panel.
- | Part No. | Description | 220V  | 240V |
|----------|-------------|-------|------|
| AAK 193  | 200V user   | ----- | 220V |
| AAK 191  | 240V user   | ----- | 240V |

This schematic diagram is based on HEZ type.  
\* marked parts are used on HEZ type only.  
\* marked parts: Differ between HEZ type on HEZ and HEZ type.  
\* marked parts: Ampere values are used (marked) on HEZ and HEZ type.  
\* Values in parenthesis are used on HEZ type.  
\* marked parts are used in HEZ and HEZ type.  
\* marked parts: Ampere values are used (marked) on HEZ type.

7.3 P. C. BOARDS CONNECTION DIAGRAM

• View from component side

- NOTE
1. This P.C.B connection diagram is viewed from the parts mounted side.
  2. The parts which have been mounted on the board can be replaced with those shown with the corresponding wiring symbols listed in the following Table.

P.C.B. pattern diagram indication	Corresponding part symbol	Part Name
		Transistor
		Radiator type transistor
		Diode
		Resistor
		Capacitor (Polarity)
		Capacitor (Non-polarity)

Others	Part Name
IC	IC
S	Switch
RY	Relay
L	Coil
F	Filter
VR	Variable resistor or Semi-fixed resistor

3. The capacitor terminal marked with (double circles) shows negative terminal.
4. The diode terminal marked with (double circles) shows cathode side.
5. The transistor terminal to which E is affixed shows the emitter.

- marked parts: Differ between HEZ type to HE and HB types.
- This P.C. BOARDS CONNECTION DIAGRAM is based on HE and HB types.
- marked parts are used in HEZ type only.
- marked parts: In HE and HB types, jumper wires are mounted instead.
- marked parts are used in HE and HB types.
- marked parts: In HEZ type, jumper wires are mounted instead.

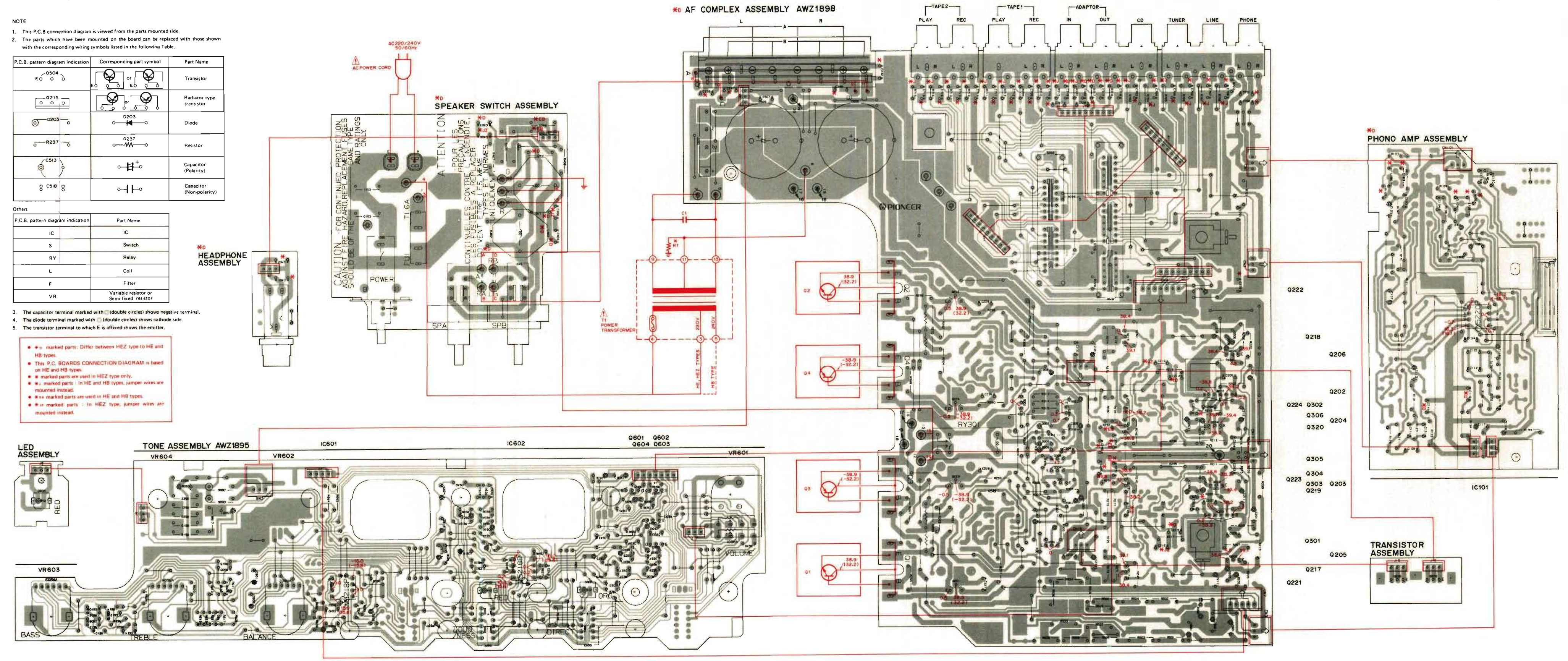

A

B

C

D

A

B

C

D

1 2 3 4 5 6 7 8 9

View from soldering side  
P.C. BOARD CONNECTION DIAGRAM

View from soldering side

A

B

C

D

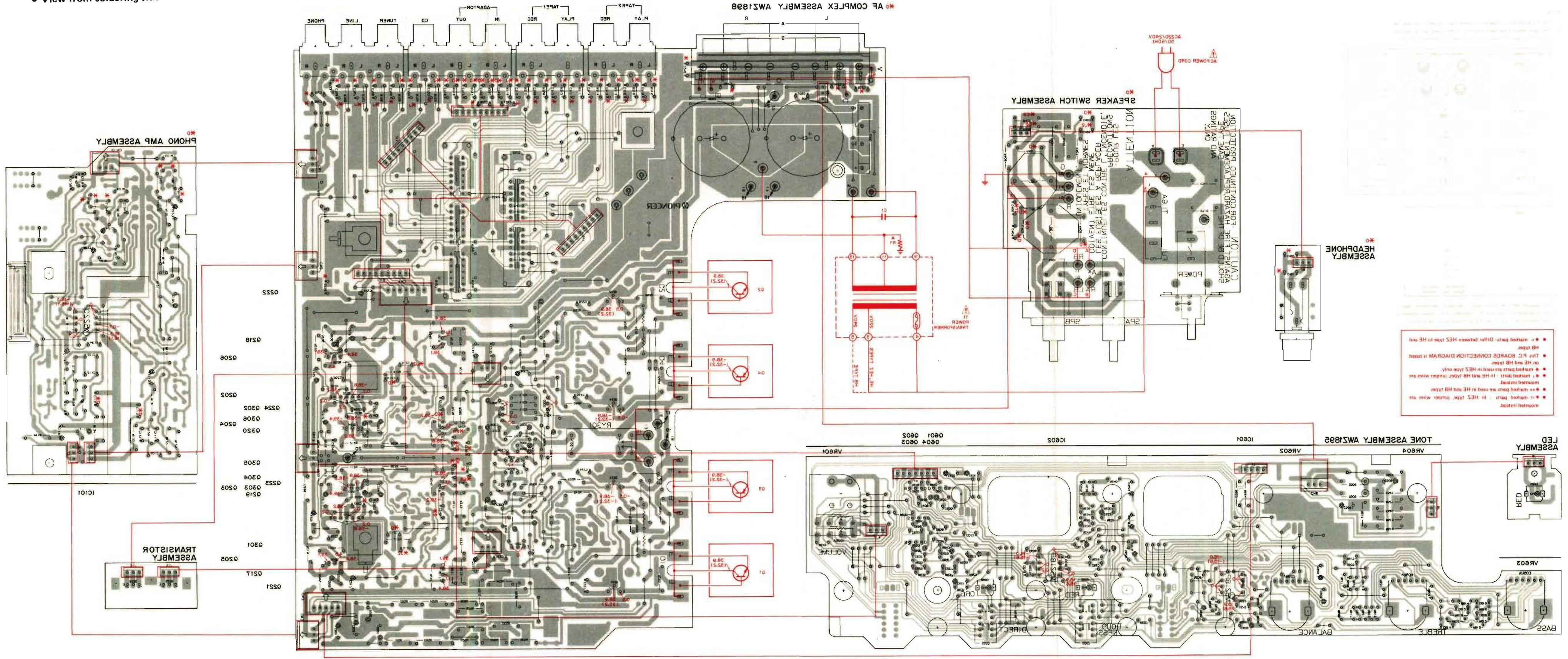

PHONO AMP ASSEMBLY

TRANSISTOR ASSEMBLY

AF COMPLEX ASSEMBLY AW21888

SPEAKER SWITCH ASSEMBLY

HEADPHONE ASSEMBLY

LED ASSEMBLY

TONE ASSEMBLY AW21885

- marked parts differ between HES type to HE and HB type
- P.C. BOARD CONNECTION DIAGRAM is based on HE and HB type
- marked parts are used in HES type only
- marked parts in HE and HB type, jumper wires are mounted instead
- marked parts are used in HE and HB type
- marked parts in HES type, jumper wires are mounted instead

A

B

C

D

1 2 3 4 5 6 7 8 9

## 8. SPECIFICATIONS

### • A-443

#### Amplifier Section

Continuous power output (both channels driven at 20 Hz to 20 kHz) \* \*

T.H.D. 0.008%, 8Ω . . . . . 60W + 60W \*

T.H.D. 0.02%, 4Ω . . . . . 80W + 80W \*

DIN Continuous power output (both channels driven at 1 kHz)

T.H.D. 1.0%, 8Ω . . . . . 70W + 70W

T.H.D. 1.0%, 4Ω . . . . . 100W + 100W

Dynamic power output (on EIA dynamic test signal)

8Ω . . . . . 75W + 75W

4Ω . . . . . 110W + 110W

2Ω . . . . . 150W + 150W

Total harmonic distortion \* \*

20 Hz to 20 kHz, 60W, 8Ω . . . . . 0.008% \*

20 Hz to 20 kHz, 80W, 4Ω . . . . . 0.02% \*

Input sensitivity/impedance

PHONO (MM) . . . . . 2.5 mV/50 kΩ

PHONO (MC) . . . . . 0.2 mV/100Ω

CD, TUNER, LINE, TAPE . . . . . 150 mV/40 kΩ

PHONO overload level

1 kHz, T.H.D. 0.008% (MM/MC) . . . . 150 mV/12 mV

Output level/impedance

TAPE REC, ADAPTOR OUTPUT . . . . . 150 mV/2.2 kΩ

Frequency response

PHONO (MM), 20 Hz to 20 kHz . . . . . ±0.3 dB

PHONO (MC), 20 Hz to 20 kHz . . . . . ±0.5 dB

CD, TUNER, LINE, TAPE 5Hz to 100 kHz . . +0 dB \*

-3

Tone control (volume control set at -40 dB position)

BASS . . . . . ±8 dB (100 Hz)

TREBLE . . . . . ±8 dB (10 kHz)

Loudness contour (volume control set at -40 dB position)

+5dB (100 Hz)/+3 dB (10 kHz)

Filter (SUBSONIC) . . . . . 17 Hz (12 dB/oct.)

Signal-to-Noise ratio (IHF short circuit, A network)

PHONO (MM, 5 mV input/MC, 0.5 mV input) . . . . .

93 dB/74 dB \* \*

CD, TUNER, LINE, TAPE . . . . . 107 dB \* \*

Signal-to-Noise ratio (DIN, continuous power/50 mW)

PHONO (MM) . . . . . 74 dB/63 dB \*

CD, TUNER, LINE, TAPE . . . . . 87 dB/65 dB \*

#### Power Supply/Miscellaneous

Power requirements

U.K. model . . . . . a.c.240V, 50/60 Hz

Other destination models . . . . . AC 110V/120-127V,

/220V/240V (switchable), 50/60 Hz

Power consumption . . . . . 550W

Dimensions . . . . . 420(W) × 348(D) × 126(H) mm

16-1/2(W) × 13-11/16(D) × 4-15/16(H) in

Weight (without package) . . . . . 8.1 kg (17 lb 14 oz)

#### Accessories

Operating instructions . . . . . 1

- Specifications and design subject to possible modification without notice, due to improvements.

\* Measured with the DIRECT switch set to ON.

\* \* Measured by Audio Spectrum Analyzer.

• **A-333**

**Amplifier Section**

Continuous power output (both channels driven at 20 Hz to 20 kHz) \* \*

T.H.D. 0.02%, 8Ω . . . . . 40W + 40W \*  
 T.H.D. 0.03%, 4Ω . . . . . 50W + 50W \*

DIN Continuous power output (both channels driven at 1 kHz)

T.H.D. 1.0%, 8Ω . . . . . 55W + 55W  
 T.H.D. 1.0%, 4Ω . . . . . 72W + 72W

Dynamic power output (on EIA dynamic test signal)

8Ω . . . . . 55W + 55W  
 4Ω . . . . . 90W + 90W  
 2Ω . . . . . 100W + 100W

Total harmonic distortion \* \*

20 Hz to 20 kHz, 40W, 8Ω . . . . . 0.02% \*  
 20 Hz to 20 kHz, 50W, 4Ω . . . . . 0.03% \*

Input sensitivity/impedance

PHONO (MM) . . . . . 2.5 mV/50 kΩ  
 CD, TUNER, LINE, TAPE . . . . . 150 mV/40 kΩ

PHONO overload level

1 kHz, T.H.D. 0.02% (MM) . . . . . 150 mV

Output level/impedance

TAPE REC, ADAPTOR OUTPUT . . . . . 150 mV/2.2 kΩ

Frequency response

PHONO (MM), 20 Hz to 20 kHz . . . . . ±0.3 dB  
 CD, TUNER, LINE, TAPE 5Hz to 100 kHz . . . . . +0  
 -3 dB \*

Tone control (volume control set at -40 dB position)

BASS . . . . . ± 8 dB (100 Hz)  
 TREBLE . . . . . ± 8 dB (10 kHz)

Loudness contour (volume control set at -40 dB position)  
 + 5dB (100 Hz)/+ 3 dB (10 kHz)

Signal-to-Noise ratio (IHF short circuit, A network)

PHONO (MM, 5 mV input) . . . . . 89 dB \*  
 CD, TUNER, LINE, TAPE . . . . . 107 dB \*

Signal-to-Noise ratio (DIN, continuous power/50 mW)

PHONO (MM) . . . . . 73 dB/63 dB \*  
 CD, TUNER, LINE, TAPE . . . . . 86 dB/65 dB \*

**Power Supply/Miscellaneous**

Power requirements

U.K. model . . . . . a.c.240V, 50/60 Hz

Power consumption

U.K. models . . . . . 410W

Dimensions . . . . . 420(W) × 348(D) × 126(H) mm

16-1/2(W) × 13-11/16(D) × 4-15/16(H) in

Weight (without package) . . . . . 7.0 kg (17 lb 7 oz)

**Accessories**

Operating instructions . . . . . 1

- Specifications and design subject to possible modification without notice due to improvements.

\* Measured with the DIRECT switch set to ON.

\* \* Measured by Audio Spectrum Analyzer.

# 9. PANEL FACILITIES

The illustration shows model A-443.

Model A-333 is not equipped 7, 8 and 11.

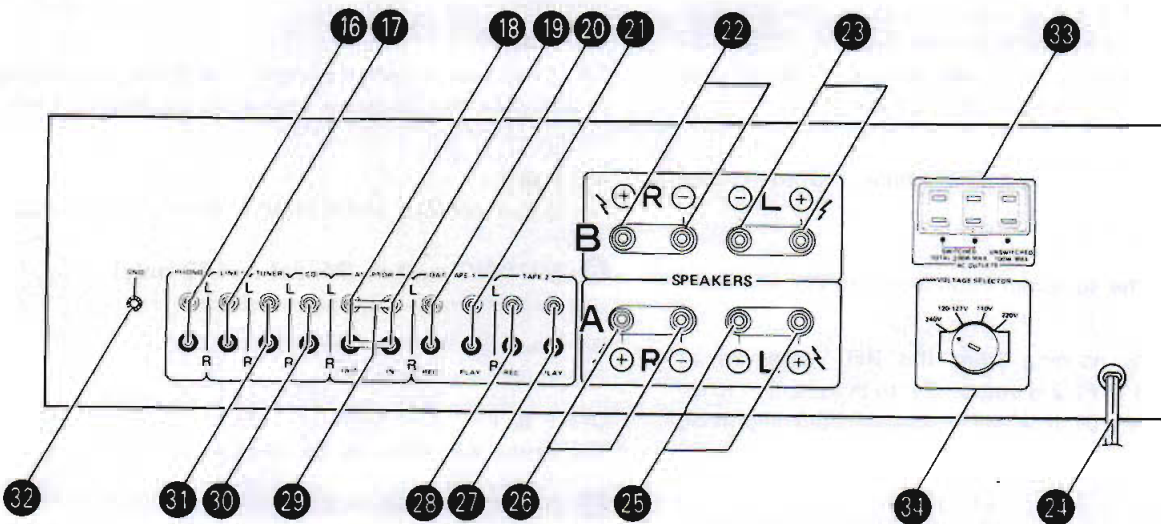
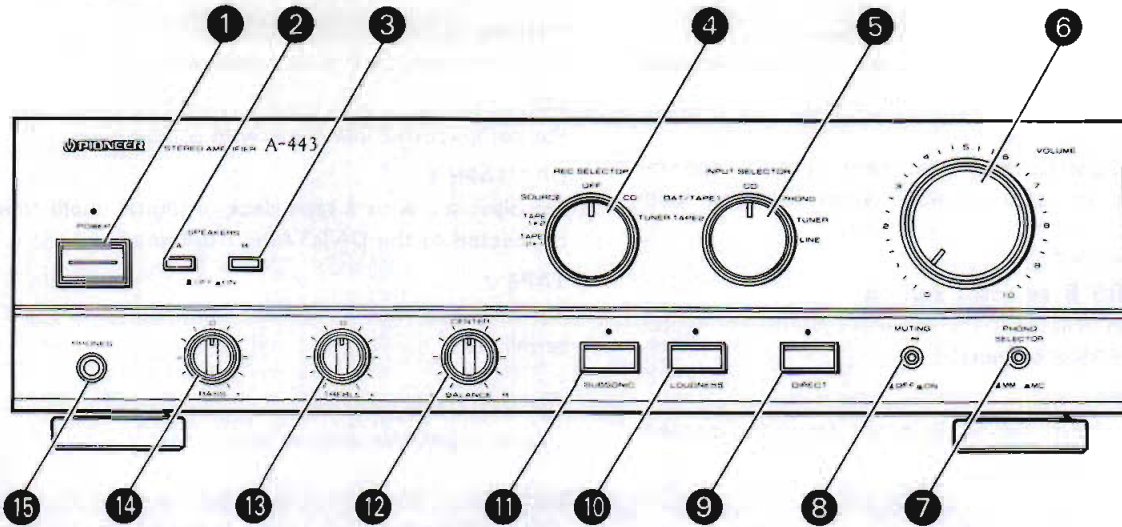

The U.K. models (A-443 and A-333) are not equipped with 33, 34.

**[FRONT PANEL]****① POWER switch/indicator**

Press to turn power to the unit ON and OFF.

**② SPEAKERS A selector switch**

Use this switch to listen to the speaker systems connected to the SPEAKERS A terminals.

**ON (  ) :**

Depressed position: Sound is heard from the speaker systems.

**OFF (  ) :**

Released position: No sound is heard from the speaker systems. Set to this position when listening with headphones.

**③ SPEAKERS B selector switch**

Use this switch to listen to the speaker systems connected to the SPEAKERS B terminals.

**ON (  ) :**

Depressed position: Sound is heard from the speaker systems.

**OFF (  ) :**

Released position: No sound is heard from the speaker systems. Set to this position when listening with headphones.

**④ REC SELECTOR switch**

When this switch is set to a position other than SOURCE or OFF, the equipment selected by the REC SELECTOR switch can be recorded from, irrespective of the settings of the INPUT SELECTOR and DIRECT switches.

**TUNER:**

To record from the equipment connected to TUNER terminals.

**CD:**

To record from the equipment connected to CD terminals.

**OFF:**

In this position, nothing from the REC terminals of DAT/TAPE 1 and TAPE 2 is output. Set to this position when not recording; the tape deck will be disconnected, improving sound quality.

**SOURCE:**

To record from the equipment selected by the INPUT SELECTOR switch.

**TAPE:**

1 ► 2 — To record (copy) from the tape deck of DAT/TAPE 1 terminals, to the tape deck of TAPE 2 terminals.

2 ► 1 — To record (copy) from the tape deck of TAPE 2 terminals, to the tape deck of DAT/TAPE 1 terminals.

**⑤ INPUT SELECTOR switch**

Use to select the playback source.

**LINE:**

For playback with a component connected to the LINE terminals.

**TUNER:**

For AM or FM broadcast reception with a tuner.

**PHONO:**

For record playback with a turntable.

**CD:**

For compact disc playback with a CD player.

**DAT/TAPE 1:**

For playback with a tape deck or digital audio tape deck connected to the DAT/TAPE 1 terminals.

**TAPE 2:**

For playback with a tape deck connected to the TAPE 2 terminals.

**⑥ VOLUME control**

Use to adjust the volume level.

**NOTE:**

*This unit is equipped with a circuit that attenuates the LOUDNESS and TONE effect as volume is turned up.*

**⑦ PHONO SELECTOR switch (Model A-443 only)**

Set in accordance with the type of cartridge used with your turntable.

**MM (  ) :**

Set to this position when using a moving magnet cartridge, or a moving coil cartridge with a high output of 1 mV or more.

**MC (  ) :**

Set to this position when using a moving coil cartridge.

**⑧ MUTING switch (Model A-443 only)**

Use to temporarily cut sound volume.

**ON (  ) :**

The sound is cut off.

**OFF (  ) :**

The sound will return to its previous volume.

**⑨ DIRECT switch/indicator**

Use this switch/indicator when you do not wish to pass the output from input terminal equipment through the various frequency adjusting circuits (SUBSONIC, BASS, TREBLE, BALANCE, LOUDNESS) and adaptor terminals (ADPT).

**ON:**

The indicator lights: The signals input through the input terminals are reproduced without passing through the various frequency adjusting circuits. This results in flat, pure sound which is a more faithful reproduction of the input source.



**OFF:**

The indicator goes out: The signal passes through the various frequency adjusting circuits.

**10 LOUDNESS switch/indicator**

Use when listening at low volume levels.

**ON:**

The indicator lights: Boosts low and high frequencies to give added punch to playback even at low volume levels.

**OFF:**

The indicator goes off: Should normally be left in this position.

**NOTE:**

*This switch does not operate when the DIRECT switch is in the ON position.*

**11 SUBSONIC filter switch/indicator (Model A-443 only)**

Use this switch when playing records with coarse grooves.

**OFF:**

Released position; leave in this position for normal playback.

**ON:**

Depressed position (the indicator lights). In this position, frequencies of 17 Hz and below are cut, eliminating super-low-frequency noise caused by coarse record grooves, and thus helping prevent sound distortion.

**NOTE:**

*This switch does not operate when the DIRECT switch is in the ON position.*

**12 BALANCE control**

Should normally be left in the center position. Adjust the balance if the sound is louder from one of the speakers. If the right side is louder, turn toward the L(left) position and if the left side is louder, turn toward the R(right) position.

**NOTE:**

*This control does not operate when the DIRECT switch is in the ON position.*

**13 TREBLE tone control**

Use to adjust the high-frequency tone. The center position is the flat (normal) position. When turned to the right, high-frequency tones are emphasized; when turned to the left, high-frequency tones are de-emphasized.

**NOTE:**

- *This control does not operate when the DIRECT switch is in the ON position.*
- *At volume levels lower than "4", the set tone control effect is obtained.*  
*At volume levels higher than "4", the effect becomes increasingly weaker.*

**14 BASS tone control**

Use to adjust the low-frequency tone. The center position is the flat (normal) position. When turned to the right, low-frequency tones are emphasized; when turned to the left, low-frequency tones are de-emphasized.

**NOTE:**

- *This control does not operate when the DIRECT switch is in the ON position.*
- *At volume levels lower than "4", the set tone control effect is obtained.*  
*At volume levels higher than "4", the effect becomes increasingly weaker.*

**15 PHONES jack**

When using headphones, insert the plug into this jack.

**[REAR PANEL]****16 PHONO terminals.****17 LINE terminals.****18 ADAPTOR OUT terminals.****19 ADAPTOR IN terminals.****20 DAT/TAPE 1 REC terminals.****21 DAT/TAPE 1 PLAY terminals.****22 SPEAKERS B terminals (right channel).****23 SPEAKERS B terminals (left channel).****24 Power cord.**

Connect this cord to an AC wall socket, or the AC outlet of an audio timer.

**25 SPEAKERS A terminals (left channel)****26 SPEAKERS A terminals (right channel)****27 TAPE 2 PLAY terminals.****28 TAPE 2 REC terminals.****29 Shorting bars.****30 CD terminals.****31 TUNER terminals.****32 Turntable ground terminal (GND).****33 AC OUTLETS****34 VOLTAGE SELECTOR**